

	[kg]	Article n°
Climbing bracket MF240 Kletterkonsole MF240 consisting of:	172.1	580650000
(A) Horizontal profile MF with handrail post Length: 251 cm Height: 155 cm	88.5	581618000
(B) Vertical profile MF80 Height: 213 cm	44.0	580652000
(C) Pressure strut MF long Galvanised Length: 252.9 cm	24.7	580653000
(D) Pressure strut MF short Galvanised	16.3	580654000

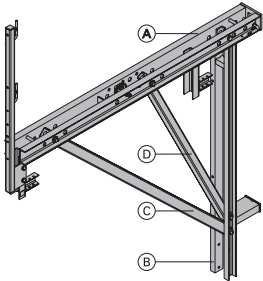

Travelling unit MF Fahrenheit MF consisting of:	135.6	580655000
(A) Travelling gear MF Galvanised Length: 128 cm Height: 22 cm	32.3	580656000
(B) Plumbing spindle MF 3.00m Length: 166-229 cm	23.0	580657000
(C) Vertical waling MF 3.00m Galvanised	76.8	580658000

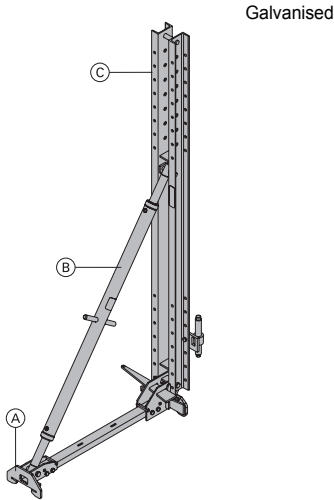

Plumbing spindle MF 4.50m Einrichtungsspindel MF 4,50m Galvanised Length: 262 - 345 cm	46.0	580664000
--	-------------	------------------

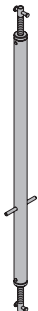

	[kg]	Article n°
Vertical waling MF 4.50m Fahrriegel MF 4,50m Galvanised	123.8	580663000



Vertical waling extension MF Fahrriegelverlängerung MF Galvanised Height: 144 cm	41.5	580659000
--	-------------	------------------

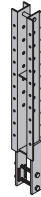





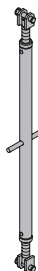

Vertical profile MF160 Vertikalprofil MF160 Galvanised Height: 208 cm	90.5	580660000
---	-------------	------------------

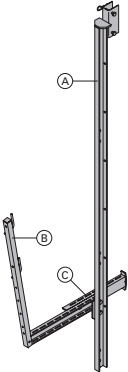
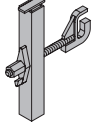

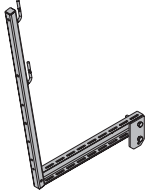
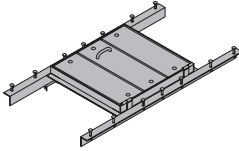
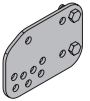
Pressure spindle MF240 Druckspindel MF240 Galvanised Height: 166 - 226 cm	26.0	580680000
---	-------------	------------------

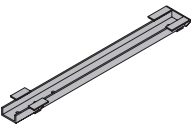
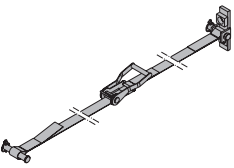
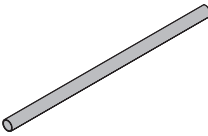
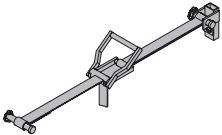

	[kg]	Article n°		[kg]	Article n°
Suspended platform MF75 5.00m Hängebühne MF75 5,00m consisting of:	69.8	580667000		2.5	580526000
(A) Suspension profile MF Height: 368 cm	43.0	580668000			
(B) Screw-on access bracket MF75 Galvanised Length: 113 cm Height: 152 cm	19.0	580669000			
(C) Distance profile MF Length: 71 cm	7.8	580670000			
 Galvanised			 Galvanised Length: 26 cm Height: 31 cm		
			 Galvanised Height: 123 - 171 cm	11.5	580470000
			 Galvanised Height: 20 cm	3.0	580478000
Screw-on access bracket MF75 Anschraubbühne MF75	19.0	580669000		37.0	580832000
 Galvanised Length: 113 cm Height: 152 cm			 Galvanised Length: 134 cm Width: 72 cm		
Swivel plate MF Schwenkplatte MF	4.5	580672000		8.8	580461000
 Galvanised Length: 29 cm Height: 20 cm			 Diameter: 16 cm Max. load: 1950 kg Follow the directions in the "Operating Instructions"!		CE
Starter block unit MF Grundblockriegel MF	23.2	580678000			
 Galvanised Length: 143 cm Width: 19 cm			Scaffold tube 48.3mm 1.00m 4.0 682014000 Scaffold tube 48.3mm 1.50m 6.0 682015000 Scaffold tube 48.3mm 2.00m 8.0 682016000 Scaffold tube 48.3mm 2.50m 10.0 682017000 Scaffold tube 48.3mm 3.00m 12.0 682018000 Scaffold tube 48.3mm 3.50m 14.0 682019000 Scaffold tube 48.3mm 4.00m 16.0 682021000 Scaffold tube 48.3mm 4.50m 18.0 682022000 Scaffold tube 48.3mm 5.00m 20.0 682023000 Scaffold tube 48.3mm 5.50m 22.0 682024000 Scaffold tube 48.3mm 6.00m 24.0 682025000 Scaffold tube 48.3mmm 4.0 682001000		
Wind bracing MF/150F/K 6.00m Windabspannung MF/150F/K 6,00m	4.7	580665000			
 Galvanised			 Galvanised		
Wind bracing MF 6.00m Windabspannung MF 6,00m	4.3	580677000		0.27	584375000
 Galvanised			 Galvanised Height: 7 cm		

	[kg]	Article n°
Screw-on coupler 48mm 50	0.84	682002000
Screw-on coupler 48mm 95	0.71	586013000

Anschraubkupplung

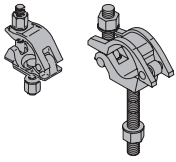

Galvanised
Width-across: 22 mm

Swivel coupler 48mm	1.5	582560000
----------------------------	------------	------------------

Drehkupplung 48mm

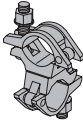

Galvanised
Width-across: 22 mm

Telescopic shaft beam 1.45-1.65m	56.0	580686000
Telescopic shaft beam 1.65-2.00m	65.0	580687000
Telescopic shaft beam 2.00-2.70m	107.5	580688000
Telescopic shaft beam 2.70-3.80m	156.5	580689000
Telescopic shaft beam 3.80-5.90m	261.0	580690000

Teleskop-Schachtträger

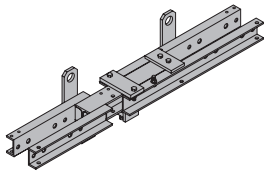

Galvanised

Pawl for shaft platform	18.0	580466000
--------------------------------	-------------	------------------

Klinke für Schachtbühne

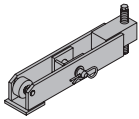

Galvanised
Length: 55 cm
Width-across: 19 mm

Box for latch 20x20x15cm	2.6	580608000
---------------------------------	------------	------------------

Aussparungskasten 20x20x15cm

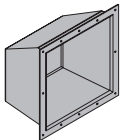

Powder-coated, blue

Plug 15.0	0.006	580609000
------------------	--------------	------------------

Verschlussstopfen 15,0



Colourless
Diameter: 1.9 cm

Main beam head	14.9	580464000
-----------------------	-------------	------------------

Bühnenkopf

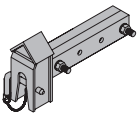

Painted blue
Length: 49 cm

Tool box GF	6.5	580390000
--------------------	------------	------------------

GF-Werkzeugbox

included in scope of supply:

(A) Reversible ratchet 1/2"	0.73	580580000
Galvanised Length: 30 cm		
(B) Fork wrench 13/17	0.08	580577000
(C) Fork wrench 22/24	0.22	580587000
(D) Fork wrench 30/32	0.80	580897000
(E) Ring spanner 17/19	0.27	580590000
(F) Extension 11cm	0.20	580581000
(G) Extension 22cm	0.31	580582000
(H) Universal joint coupling	0.16	580583000
(I) Nut for box spanner 19	0.16	580598000
(J) Box nut 13	0.06	580576000
(K) Box nut 24	0.12	580584000
(L) Box nut 30 1/2"	0.20	580575000

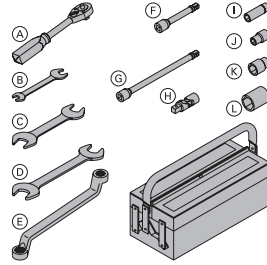

Additional tools MF	4.1	580682000
----------------------------	------------	------------------

Zusatzwerkzeuge MF

consisting of:

(A) Reversible ratchet 3/4"	1.5	580894000
Galvanised Length: 50 cm		
(B) Box nut 17 1/2"	0.07	580685000
(C) Box nut 50	0.81	581449000
(D) Extension 20cm 3/4"	0.68	580683000
(E) Transition piece A 1/2"x3/4"	0.18	580684000
(F) Universal cone spanner 15.0/20.0	0.90	581448000
Galvanised Length: 9 cm Width-across: 50 mm		

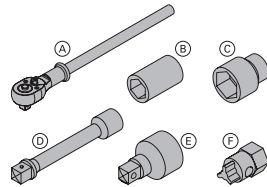

Ratchet MF 3/4"	3.9	580679000
------------------------	------------	------------------

Antriebsknarre MF 3/4"

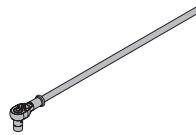

Galvanised
Length: 108 cm